

# KAYCAN

## QUICK TIPS FOR INSTALLING HORIZONTAL VINYL SIDING

For best results, please download the complete Installation Guide, found on our Kaycan website. There you will find more information on how to install vinyl siding and accessories as well as helpful videos.

Visit [kaycan.com](http://kaycan.com) for more details

### TOOLS



### STANDARD ACCESSORIES

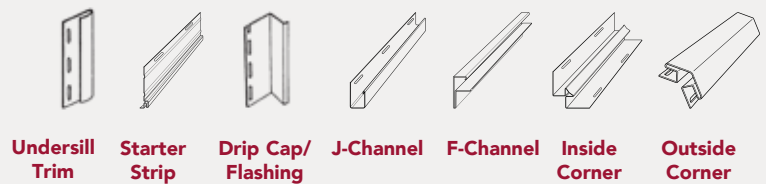

All accessories should be fastened 8"-12" max on center. Do not drive the head of the fastener tightly against the accessory nail hem. Allow approximately 1/32" (0.8mm) clearance (the thickness of a dime) between the fastener head and the vinyl.

## TIPS FOR A SUCCESSFUL INSTALL

### CUTTING VINYL SIDING

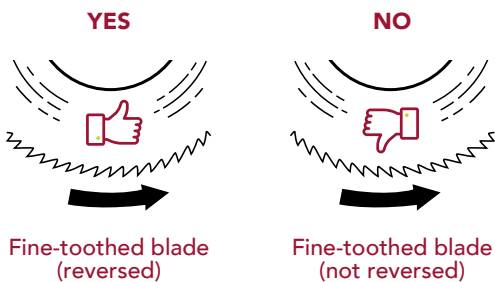

(OR USE A VINYL SIDING BLADE)

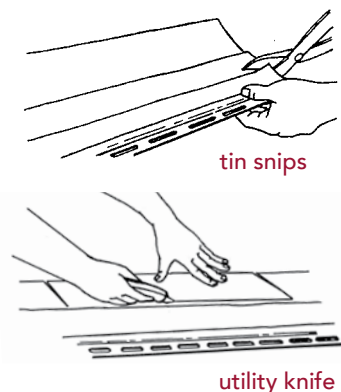

### INSTALLING VINYL ACCESSORIES

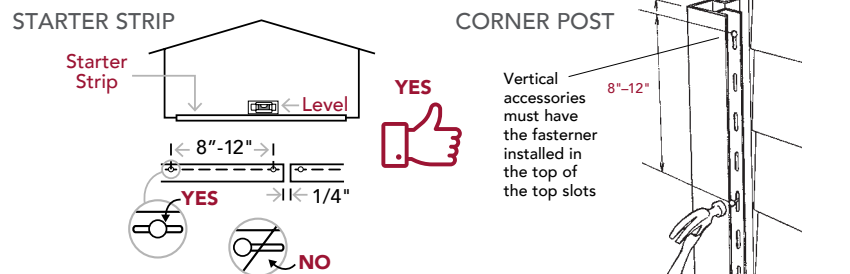

### DOORS AND WINDOWS

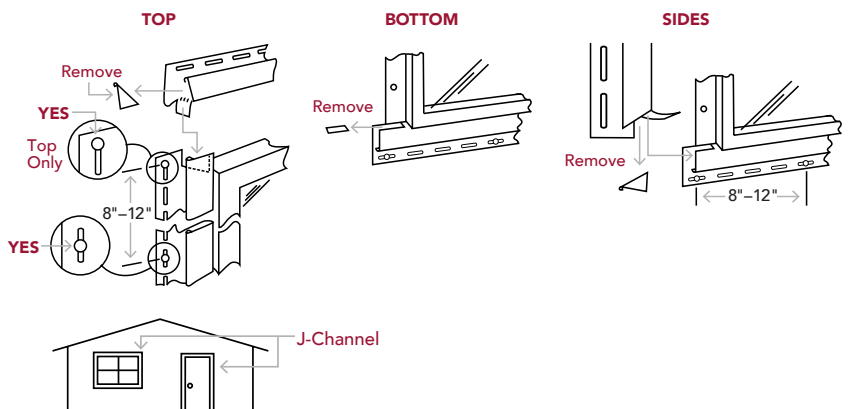

## NAILING: Vertical Accessories or Siding

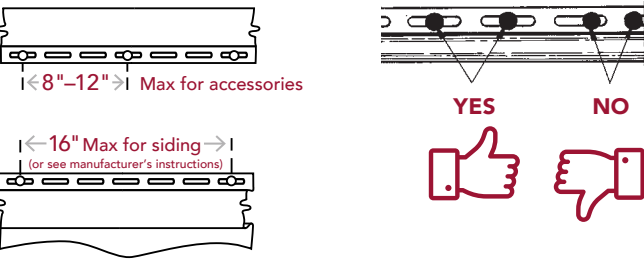
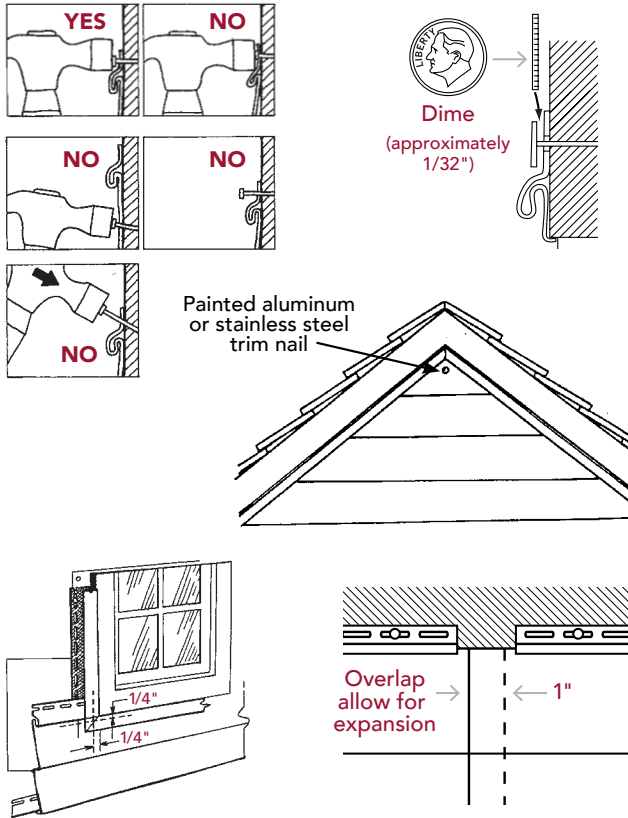

## INSTALLING PANELS

1. Minimum fastener length must be sufficient to penetrate sheathing other nailable substrate and framing a total of a minimum of 1 1/4" (32 mm) or in accordance with the manufacturer's installation instructions.
2. Do not drive the nail tight against the nail hem.
3. Leave approximately 1/32" clearance (about the thickness of a dime) between the fastener head and the nail hem.
4. Make sure that the panels and accessories move freely when fastened.
5. Leave 1/4" clearance inside all receiving channels at all openings and stops for expansion and contraction. Increase to 3/8" (9.5 mm) when installing in temperatures below 40° F.
6. When panels overlap, make sure they overlap by 1" on the face of the panel.
7. Overlap panels away from entrances and away from the point of greatest traffic.
8. Do not face-nail through siding, except for the one nail needed to finish at top of a gable.

## LOCKING PANELS

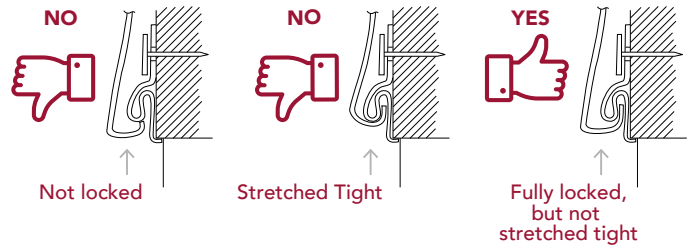

## PANEL ALIGNMENT

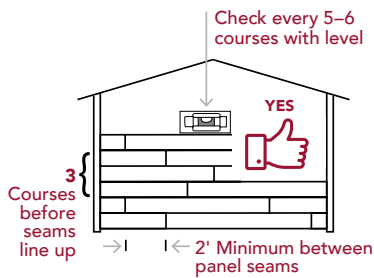

## FINISHING: Last Course in Eave Options

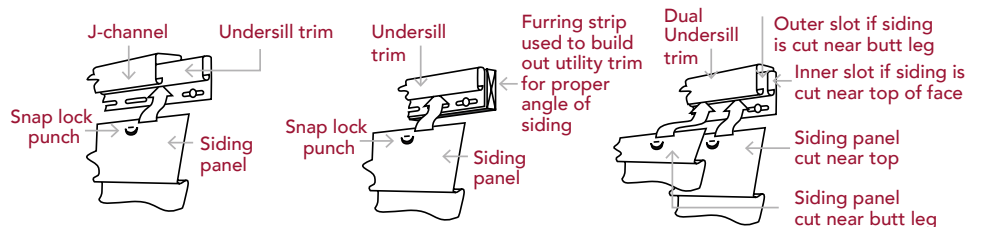

\*Snap lock punches should be about 6" on center.